

ROTEL hi-fi

ROTEL hi-fi

ROTEL hi-fi

ROTEL hi-fi

ROTEL hi-fi

ROTEL hi-fi

ROTEL hi-fi

ROTEL hi-fi

ROTEL hi-fi

ROTEL hi-fi

ROTEL hi-fi

ROTEL hi-fi

ROTEL hi-fi

ROTEL hi-fi

ROTEL hi-fi

ROTEL hi-fi

ROTEL hi-fi

ROTEL hi-fi

ROTEL hi-fi

ROTEL hi-fi

RCD-991

STEREO COMPACT DISC PLAYER

STEREO-CD-PLAYER

LECTEUR DE DISQUES COMPACTS STÉRÉO

LECTOR DE DISCOS COMPACTOS

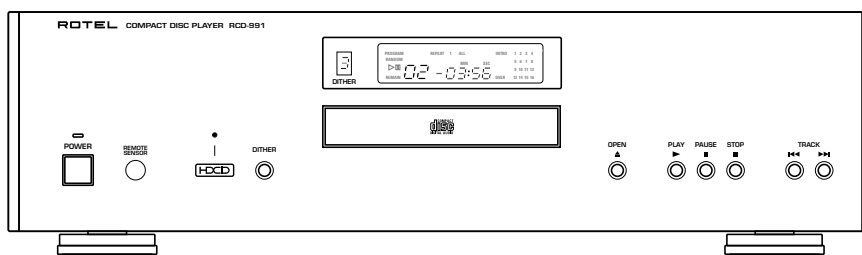

Owner's Manual

Guide d'utilisation

Bedienungsanleitung

Manual de Instrucciones

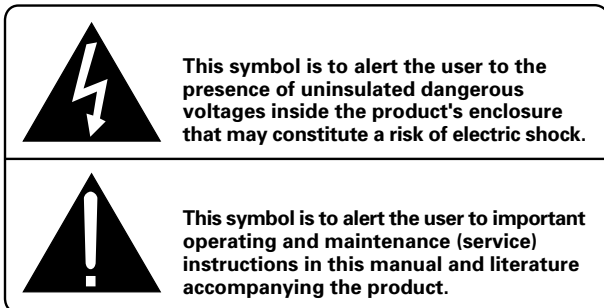
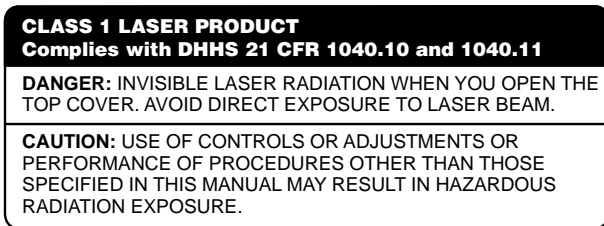
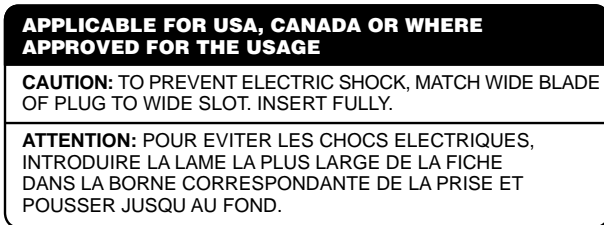

WARNING:
There are no user serviceable parts inside. Refer all servicing to qualified service personnel.

WARNING:
To reduce the risk of fire or electric shock, do not expose the unit to moisture or water. Do not allow foreign objects to get into the enclosure. If the unit is exposed to moisture, or a foreign object gets into the enclosure, immediately disconnect the power cord from the wall. Take the unit to a qualified service person for inspection and necessary repairs.

Read all the instructions before connecting or operating the component. Keep this manual so you can refer to these safety instructions.

Heed all warnings and safety information in these instructions and on the product itself. Follow all operating instructions.

Clean the enclosure only with a dry cloth or a vacuum cleaner.

Keep the ventilation inlets on the unit unobstructed. For example, do not place the unit on a bed, sofa, rug, or similar surface that could block the ventilation slots. If the component is placed in a bookcase or cabinet, there must be sufficient clearance around the unit and ventilation of the cabinet to allow proper cooling.

Keep the component away from radiators, heat registers, stoves, or any other appliance that produces heat.

The unit must be connected to a power supply only of the type and voltage specified on the rear panel of the unit.

Connect the component to the power outlet only with the supplied power supply cable or an exact equivalent. Do not modify the supplied cable in any way. Do not attempt to defeat grounding and/or polarization provisions. The cable should be connected to a 2-pin polarized wall outlet, matching the wide blade of the plug to the wide slot of the receptacle. Do not use extension cords.

Do not route the power cord where it will be crushed, pinched, bent at severe angles, exposed to heat, or damaged in any way. Pay particular attention to the power cord at the plug and where it exits the back of the unit.

The power cord should be unplugged from the wall outlet if the unit is to be left unused for a long period of time.

Immediately stop using the component and have it inspected and/or serviced by a qualified service agency if:

- The power supply cord or plug has been damaged.
- Objects have fallen or liquid has been spilled into the unit.
- The unit has been exposed to rain.
- The unit shows signs of improper operation
- The unit has been dropped or damaged in any way

Place the unit on a fixed, level surface strong enough to support its weight. Do not place it on a moveable cart that could tip over.



Figure 1: Controls and Connections / Figure 1: Commandes et prises
Abbildung 1: Bedienelemente und Anschlüsse / Figura 1: Controles y Conexiones

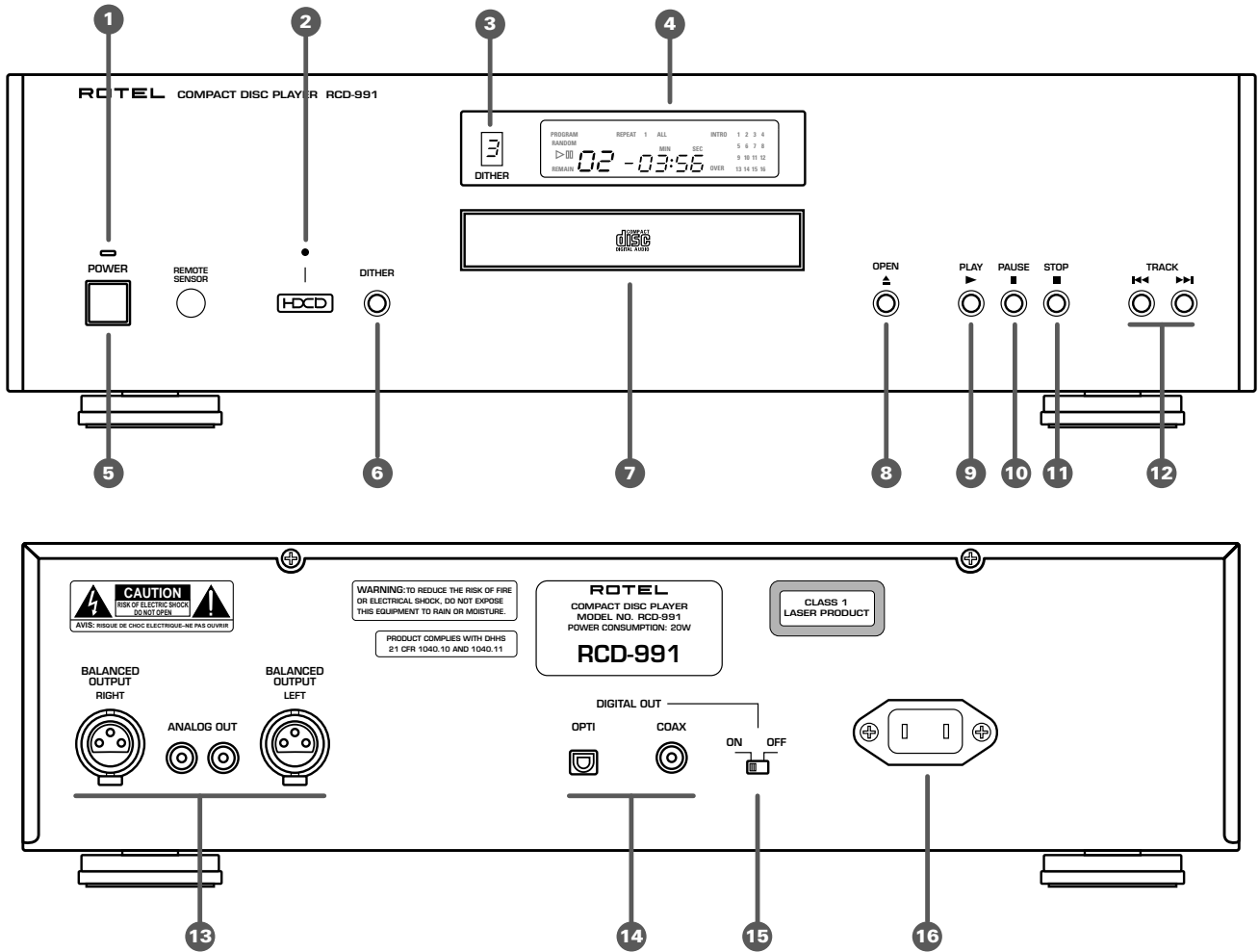

Figure 2: Analog Outputs / Figure 2: Sorties analogiques
 Abbildung 2: Analog-Ausgangsbuchsen / Figura 2: Salidas Analógicas

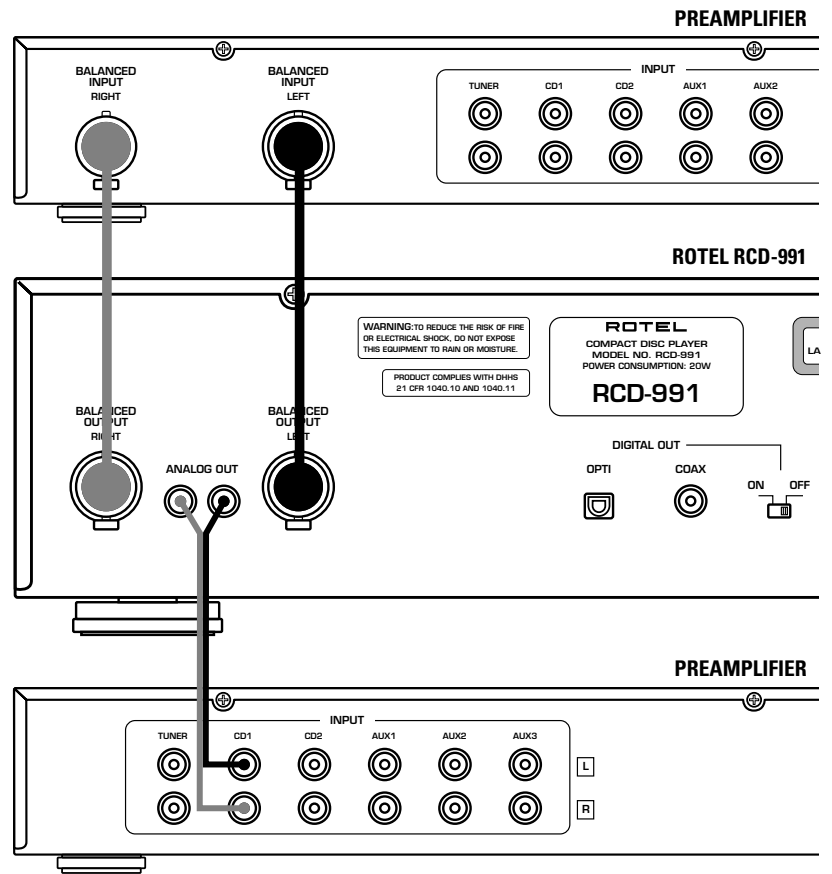
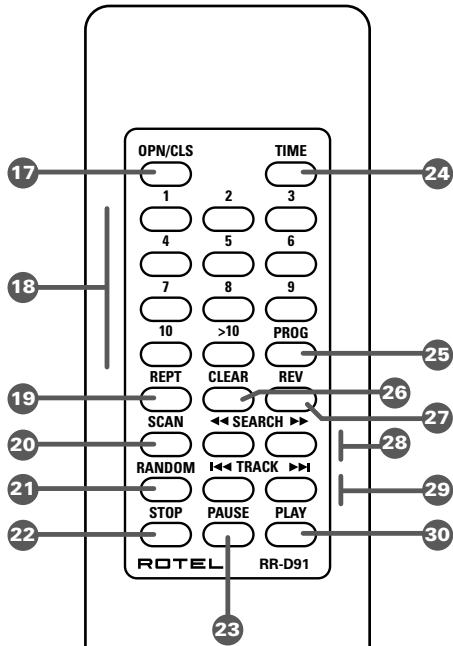
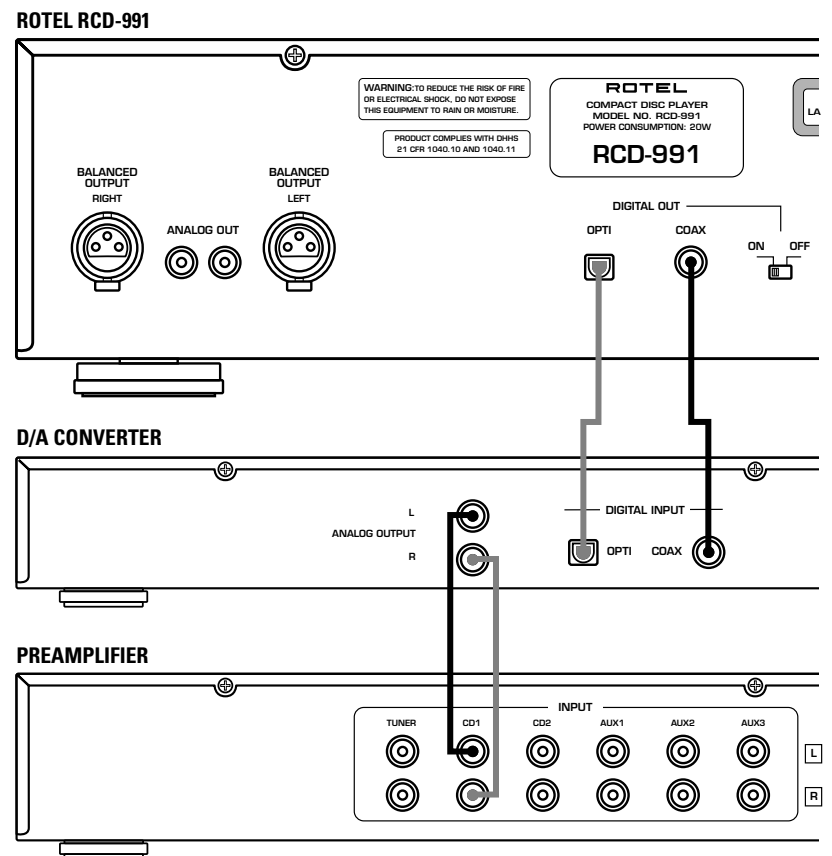

Figure 3: Digital Outputs / Figure 3: Sorties numériques
 Abbildung 2: Digital-Ausgangsbuchse / Figura 3: Salidas Digitales



Contents (circled numbers refer to illustration)

About Rotel _____	1
Getting Started _____	1
A Few Precautions	1
Placement	2
AC Power and Control _____	2
AC Power Input ⑯	2
Power Switch ⑤ and Power Indicator ①	2
Output Connections _____	2
Analog Outputs ⑬	2
Digital Outputs ⑭ and Switch ⑮	2
Operation _____	3
Infrared Remote Control	3
Display ④	3
Disc drawer ⑦	3
Transport Control Buttons _____	3
OPEN Button ⑧ ⑰	3
PLAY Button ⑨ ⑳	3
PAUSE Button ⑩ ㉓	3
STOP Button ⑪ ㉒	3
TRACK Buttons ⑫ ㉑	3
DIRECT ACCESS Buttons (remote only) ⑱	4
SEARCH Buttons (remote only) ㉔	4
Additional Features _____	4
HDCD® ②	4
PROGRAM Button (remote only) ㉕	4
REVIEW Button (remote only) ㉗	4
CLEAR Button (remote only) ㉖	5
RANDOM Button (remote only) ㉙	5
REPEAT Button (remote only) ㉘	5
SCAN Button (Remote Only) ㉚	5
TIME Button (Remote Only) ㉜	5
DITHER Button (front panel only) ⑥	5
DITHER Display ③	5

About Rotel

A family whose passionate interest in music led them to manufacture high fidelity components of uncompromising quality founded Rotel over 30 years ago. Through the years that passion has remained undiminished and the family goal of providing exceptional value for audiophiles and music lovers regardless of their budget, is shared by all Rotel employees.

The engineers work as a close team, listening to, and fine tuning each new product until it reaches their exacting musical standards. They are free to choose components from around the world in order to make that product the best they can. You are likely to find capacitors from the United Kingdom and Germany, semi conductors from Japan or the United States, while toroidal power transformers are manufactured in Rotel's own factory.

Rotel's reputation for excellence has been earned through hundreds of good reviews and awards from the most respected reviewers in the industry, who listen to music every day. Their comments keep the company true to its goal - the pursuit of equipment that is musical, reliable and affordable.

All of us at Rotel, thank you for buying this product and hope it will bring you many hours of enjoyment.

Getting Started

Thank you for purchasing the Rotel RCD-991 single disc Compact Disc Player. With its precision transport, 20-bit 8-times oversampling digital circuitry, dual-differential 20-bit D/A converters, user-selectable dither, HDCD® capability, and Rotel's Balanced Design, the RCD-991 ensures the highest level of audio performance. In addition, full analog output capability (both balanced and unbalanced) and digital outputs (both optical and coaxial) provide maximum flexibility in system configuration. When used as a stand alone CD player or as a CD transport with an out-board D/A converter, your Rotel RCD-991 will provide years of enjoyment.

A Few Precautions

Please read this manual carefully. In addition to installation and operating instructions, it provides valuable information on various RCD-991 system configurations as well as general information that will help you get optimum performance from your system. Please contact your authorized Rotel retailer for answers to any questions you might have. In addition, all of us at Rotel welcome your questions and comments.

Save the RCD-991 shipping carton and all enclosed packing material for future use. Shipping or moving the RCD-991 in anything other than the original packing material may result in severe damage that is not covered by the warranty.

Fill out and send in the owner's registration card packed with the RCD-991. Also be sure to keep the original sales receipt. It is your best record of the date of purchase, which you will need in the event warranty service is required.

Placement

Use common sense when placing the RCD-991 in a cabinet or when stacking other equipment. Make sure that the shelf or cabinet can support its weight. Do not stack heavy components on top of the RCD-991. Avoid placing the unit where it may be subject to excessive heat such as on top of a large power amplifier or near a heat register. For best performance, avoid placing the unit where it may be subject to vibration, such as near a speaker.

AC Power and Control

AC Power Input 16

Your RCD-991 is configured at the factory for the proper AC voltage in the country where you purchased it (either 115 volts or 230/240 volts). The AC line configuration is noted on a decal on the back panel.

Note: *Should you move your CD player to another country, it may be possible to reconfigure it for use on a different line voltage. Do not attempt to perform this conversion yourself. Opening the enclosure of the RCD-991 exposes you to dangerous voltages. Consult a qualified service person or the Rotel factory service department for information.*

The RCD-991 should be plugged directly into a 2-pin polarized wall outlet or into the switched outlet on another component in your audio system. Do not use an extension cord.

Be sure the power switch on the front panel of the RCD-991 is turned off (in the "out" position). Then, connect the supplied power cord to the AC power receptacle on the rear of the unit and the AC power outlet.

If you are going to be away from home for an extended period of time such as a month-long vacation, it is a sensible precaution to unplug your CD player (as well as other audio and video components) while you are away.

Power Switch 5 and Power Indicator 1

The power switch is located on the front panel of your CD player. To turn the CD player on, push the switch in. The LED indicator above the switch and the DISPLAY will light up, indicating that the CD player is turned on. To turn the CD player off, push the button again and return it to the "out" position.

Note: *If you are using a switched outlet to turn on and off your CD player, you should leave the power switch in the "on" position. When AC power is applied to the unit, it will power up in fully active mode.*

Output Connections

The RCD-991 gives you a choice of analog or digital output signals. The analog output signal from the built-in Digital to Analog converter is used with conventional analog audio components. The digital output, which provides an unprocessed digital data signal, is used with outboard D/A converters or digital processors.

Note: *To prevent loud noises that neither you nor your speakers will appreciate, make sure the CD player is turned off when you make any signal connections.*

Analog Outputs 13

[See Figure 2 for wiring illustration]

The analog output signal is available from two different types of connectors on the back panel of the RCD-991. A pair of standard RCA jacks supplies a conventional unbalanced analog output signal from the RCD-991 to the source inputs of an audio preamplifier, integrated amplifier, or receiver. Alternatively, a pair of three-pin XLR-style jacks supplies a balanced-line analog output signal for use with preamplifiers that are equipped with similar input connections.

RCA connections are found on virtually all components. Not as many components feature XLR connections, but, when available, they may provide less chance of noise and improved signal quality. Use whichever type of signal connection matches your particular system configuration.

Select high quality audio interconnect cables. Connect the left channel output of the RCD-991 to the left channel source input on the preamplifier or other component. Connect the right output of the RCD-991 to the right channel source input on the preamplifier or other component.

Digital Outputs 14 and Switch 15

[See Figure 3 for wiring illustration]

If you are using the RCD-991 as a disc transport with an outboard D/A converter or other digital processor, you need an unprocessed digital data stream from the RCD-991, taken before the built-in D/A converter. This signal is supplied by the RCD-991's back-panel digital output jacks.

Both optical and coaxial digital signal connectors are provided. Use whichever type best matches your other components. Using a standard 75 ohm coax or optical digital cable, connect the appropriate RCD-991 digital output jack to the digital input connector on the outboard D/A converter.

A switch to the right of the digital outputs enables or disables the digital outputs. To use the digital outputs, this switch must be in the on position. If you are not using the digital outputs, we recommend turning the switch off, because it removes the digital output circuitry from the signal path.

Operation

The RCD-991 can be operated using its front panel buttons or from corresponding buttons on the supplied infrared remote control. Specific instructions for each of these controls are detailed below. Some of the buttons are duplicated on the front panel *and* on the IR remote control. However, there are many instances where the buttons are only available on one or the other. These are noted in the following instructions.

Infrared Remote Control

Before using the IR remote control, it is necessary to install two "AAA" batteries (supplied). Remove the plastic cover on the back of the IR remote, install the batteries (observing the + and – polarity indications), and reinstall the cover.

To use the IR remote control, aim it at the IR sensor located on the front panel of the RCD-991.

Display 4

A lighted DISPLAY on the front panel of the RCD-991 provides useful information about the status of the unit, activation of special features, and track/time information for the disc being played. Each of these indicators is described in the detailed operating instructions that follow.



Disc drawer 7

A motor-driven disc drawer, located in the center of the RCD-991, slides out to accept a compact disc and retracts to play the disc. **Place the compact disc in the drawer label-side up.** Make sure the disc is properly centered in the tray.

The drawer can be closed in two ways: pushing the OPEN button or pushing the PLAY button.

Transport Control Buttons

These buttons provide basic control functions for the disc transport mechanism. Except where noted, all functions are available on the RCD-991 front panel and the IR remote control. The circled numbers provide a convenient reference for finding the button on the illustrations of the RCD-991 and the IR remote control at the front of this manual.

OPEN Button 8 17

When the transport disc drawer is closed, pressing this button automatically opens the drawer. To close the drawer, press this button again. The drawer can also be closed by pressing the PLAY button.

When the drawer is open, the DISPLAY will read "OPEN". When it is closed with no disc, the display will read "NO DISC". When the drawer closes with a disc inserted, the DISPLAY will indicate the number of tracks on the disc and the total time of the disc in minutes and seconds.

PLAY Button 9 30

Press the PLAY button to start playing the disc. If the disc drawer is open, it will close automatically. The number of the track being played and the time remaining will be shown in the display, along with the PLAY indicator.

Normally, the disc will start playing with the first track. However, you can select a different track using the TRACK buttons or the DIRECT ACCESS buttons (see below) before pressing the PLAY button to start playing a different track.

PAUSE Button 10 23

This button is used to temporarily suspend play. The disc continues to spin and play will be resumed from the current position. The PAUSE indicator will light in the DISPLAY.

To resume playing the disc, press the PAUSE button again or press the PLAY button.

STOP Button 11 22

This button stops a disc that is playing and resets the player, i.e. if play is resumed, the disc will start over from the first track. Pressing the STOP button twice cancels any programmed selections (see below).

TRACK Buttons 12 29

These buttons are used to select tracks on the disc. When a disc is playing, pressing the right TRACK button advances to the beginning of the next track. Pressing the left TRACK button returns to the beginning of the current track. Pressing twice quickly in succession returns to the beginning of the previous track. The new track number appears in the DISPLAY.

These buttons are also used to select a track before pressing the PLAY button or when memorizing tracks for the PROGRAM play mode (see below). These selections are made by continuously pressing the TRACK buttons until the desired track is reached.

In PROGRAM mode, the TRACK buttons advance or reverse to the next track in the memorized selection list.

DIRECT ACCESS Buttons (remote only) 18

These eleven numeric buttons (labeled 1 through 10 and >10) are used to directly access a track from the remote control instead of stepping through the tracks using the TRACK buttons.

The first ten tracks on a disc can be selected by pressing the corresponding button. For example, to play the third track, press the 3 button on the remote control. The number of the selected track will appear in the center of the DISPLAY and the track will play.

To select track 11 or higher, first press the >10 button, then all of the digits of the desired track number. For example, to play track 12, press >10, then 1, and then 2. Use the 10 button for the 0 digit. To play track 20, press >10, then 2, and then 10.

There is also a four by four matrix of track numbers (1 – 16) located at the right side of the display. This display indicates all of the tracks on the disc. If there are more than 16 tracks on the disc, all of the digits will light accompanied by the word OVER, regardless of which track is playing. This matrix is independent of the main numeric area of the DISPLAY, which will always indicate the currently playing track, even if above 16.

The DIRECT ACCESS buttons may also be used to memorize tracks in PROGRAM mode (see below).

SEARCH Buttons (remote only) 28

These buttons fast forward or fast reverse through the currently playing disc as long as they are pressed. While the buttons are pressed, you will hear high-speed audio. Releasing the buttons returns to PLAY mode.

Additional Features

These convenience features add extra functionality to the RCD-991, including the ability to play high-definition HDCD discs, to memorize a group of tracks to be played, to repeat a disc, program, or track over and over, to play the tracks on a disc in random order, to automatically play the first 10 seconds of each track, to select from several available time displays, and to select different dither modes.

HDCD® 2

HDCD® (High Definition Compatible Digital) is a system developed by Pacific Microsonics, Inc. that enhances a CD's sound quality. It is based on the latest research in how we hear and depends on sophisticated algorithms (or mathematical equations) to optimize the link between the recording studio and our home.

In the recording process, an HDCD encoder analyzes music to determine how best to reproduce it. The encoder then embeds a series of instructions on a CD along with the music. These commands tell an HDCD-equipped CD player how to best reproduce the complex musical signal so that we hear even more of the original recording than conventional CDs allow us to.

In addition to properly reproducing the enhanced sound quality of HDCD-encoded discs, an HDCD-capable player performs significantly better with conventional CDs thanks to an advanced digital filter that not only provides precise upsampling but optimizes the performance of the D/A converter by minimizing quantizing errors with dither, deglitching circuits, and slew rate adjustments.

HDCD's operation is completely transparent. The system automatically senses an HDCD-encoded disc and decodes it according to the instructions recorded on the disc. The HDCD LED on the front panel lights to when an HDCD-encoded disc is being played.

When playing conventional CDs, you hear the music exactly as the artist intended but with a startling realism, thanks to the audible benefits of the advanced HDCD filter.

PROGRAM Button (remote only) 25

This button, labeled PROG, allows you to memorize as many as 20 tracks on the current disc for playback in a specific order. For example, you could instruct the RCD-991 to play track 5, followed by track 3, followed by track 8. Programs can only be memorized from the handheld remote control. To begin a program:

- 1) *Insert a disc and press the OPEN button to close the drawer. The RCD-991 will read the contents of the disc.*
- 2) *Press the PROGRAM button on the remote control. The PROGRAM indicator will light up in the DISPLAY, along with "P-00" indicating that the unit is waiting for the first track to be memorized.*
- 3) *Enter the first track number using the DIRECT ACCESS buttons on the remote control. Your selection will be memorized automatically and the DISPLAY indicator will change to "P-01", indicating that one track has been memorized. Continuing entering the rest of your selections using the DIRECT ACCESS buttons. There is no need to press the PROGRAM button between selections; each selection is memorized as soon as it is entered.*

Once you have memorized a play list, the RCD-991 remains in PROGRAM mode until you open the disc drawer or press the STOP button twice in succession. If you press the PLAY button, the memorized program will play instead of the entire disc, starting with the first selection in the memorized list.

When a PROGRAM has been memorized, most functions that would normally effect the entire disc operate on just the memorized program. For example, the TRACK buttons advance to the next track in the memorized program, not the next track on the disc. Likewise, the REPEAT button (see below) continuously plays the memorized program, not the entire disc.

REVIEW Button (remote only) 27

This button is used to review the memorized tracks in PROGRAM mode. Press the button and the first memorized track number will appear in order in the DISPLAY, flashing for approximately five seconds. Pressing the REVIEW button again while the track number is flashing will continue the review sequence, showing the next memorized track. Continue pressing the REVIEW button to see the complete memorized track list.

If you do not press the REVIEW button while the track number is flashing, the review process is terminated and the unit resumes whatever mode it was in before you started to review, except that the last reviewed track number will remain active and shown in the display.

Note: You may remove a selection from the play list during the review procedure using the CLEAR button, as described below.

CLEAR Button (remote only) 26

This button allows you to remove a track selection from the memorized program play list during the review procedure described above. Follow the review procedure until the desired track number is flashing. Then, instead of pressing the REVIEW button to continue, remove the displayed track by pressing the CLEAR button while the number is still flashing. You may then continue the review procedure.

RANDOM Button (remote only) 21

This instructs the CD player to play tracks from the entire disc in random order. Once all of the selections have been played once, the disc will stop playing, unless the REPEAT Button (see below) has been engaged, in which case the random play will continue until the STOP button is pressed. When the RANDOM button is engaged, the word RANDOM appears in the DISPLAY.

REPEAT Button (remote only) 19

This button allows you to repeat the current track or the entire disc continuously until the feature is cancelled by disengaging the REPEAT button or pressing STOP. The REPEAT button steps sequentially through the available options. Press the button once and the RCD-991 will repeat just the current track, displaying the indicators REPEAT 1 in the DISPLAY. Press the button a second time and the RCD-991 will repeat the entire disc, displaying REPEAT ALL in the DISPLAY. Press the button a third time to cancel the REPEAT function.

As noted above, REPEAT can be used in conjunction with the RANDOM play feature.

Note: The REPEAT function is automatically cancelled when the disc drawer is opened.

SCAN Button (Remote Only) 20

This feature automatically plays the first ten seconds of each track on the disc. To activate the feature, press the SCAN button. The word INTRO appears in the DISPLAY. To stop scanning and resume normal operation at the current track, press the SCAN button again or press the PLAY button.

TIME Button (Remote Only) 24

Normally, the RCD-991 displays the elapsed time of the currently playing track. The TIME button allows you to step through two alternative time displays. Pressing the button once displays the time remaining in the current track, which counts down as the track

continues playing. Pressing the button a second time displays the time remaining on the entire disc (or memorized program). Pressing the button a third time reverts to the standard elapsed time display. When the TIME feature is activated, the word REMAIN appears in the DISPLAY.

DITHER Button (front panel only) 6

DITHER Display 3

Dither is a very small amount of digital noise added to a signal to improve a CD player's overall sound quality. Proper types and amounts of dither can improve a digital-to-analog converter's linearity, particularly during very soft (low-level) musical passages.

Dither's precise effects vary depending on: the exact dither type and level chosen, D/A converter type, other system characteristics, and the type of music being played.

The RCD-991 allows you to choose different types and levels of dither. The effects may vary but careful listening will reveal what selection is best for your system and musical taste.

Select different dither types by sequentially pushing the DITHER button. The DITHER DISPLAY will change to indicate the kind of dither then being generated. Remember that dither-induced sonic differences are subtle and that there is no wrong setting for your RCD-991. Experiment to find the most pleasing dither selection.

The DITHER DISPLAY, located to left of the main DISPLAY, shows a single digit indicating the types of dither provided by the RCD-991 as follows:

A blank dither setting indicates that dither is off.

Dither settings from 0 through 6 are seven progressively higher levels of ultrasonic noise-shaped dither. The 0 setting provides minimum amplitude dither which corrects quantization errors only. The 1-6 settings add increasing levels of ultrasonic (30-80 kHz) weighted dither designed to smooth out non-linearity errors in multi-bit D/A converters. The 1 setting indicates the least amount of noise shaped dither; the 6 setting indicates the highest level.

A dither setting of 7 is minimum amplitude triangular PDF dither. This low level broadband dither is not weighted towards the ultrasonic range and is intended to correct quantization errors only. It has a similar effect as the 0 setting, but with a different type of noise.

RCD-991

**STEREO COMPACT DISC PLAYER
STEREO-CD-PLAYER
LECTEUR DE DISQUES COMPACTS STÉRÉO
LECTOR DE DISCOS COMPACTOS**

The Rotel Co., Ltd.

10-10 Shinsen-Cho
Shibuya-Ku
Tokyo 150-0045
Japan
Phone: +81 3-5458-5325
Fax: +81 3-5458-5310

Rotel of America

54 Concord Street
North Reading, MA 01864-2699
USA
Phone: +1 978-664-3820
Fax: +1 978-664-4109

Rotel Europe

Meadow Road
Worthing, West Sussex BN11 2RX
England
Phone: +44 (0)1903 524 813
Fax: +44 (0)1903 524 831

Rotel Deutschland

Kleine Heide 12
D-33790 Halle/Westf.
Germany
Phone: +49 5201-87170
Fax: +49 5201-73370

ROTEL*hi-fi*

ROTEL*hi-fi*

ROTEL*hi-fi*

ROTEL*hi-fi*

ROTEL*hi-fi*

ROTEL*hi-fi*

ROTEL*hi-fi*

ROTEL*hi-fi*

ROTEL*hi-fi*

ROTEL*hi-fi*

ROTEL*hi-fi*

ROTEL*hi-fi*

ROTEL*hi-fi*

ROTEL*hi-fi*

ROTEL*hi-fi*

ROTEL*hi-fi*

ROTEL*hi-fi*

ROTEL*hi-fi*

ROTEL*hi-fi*

ROTEL*hi-fi*